



imagine[®]
it

*Decorate it. Modify it. **Customize it.***



Your company's personal image

Through our Imagine It® program we have taken the capability of creating customized uniform items and apparel to a new level. The possibilities are (almost) endless. This unique program allows you to select stock apparel from our many brands and modify or customize them to create unique uniforms that cater directly to your customer's needs.

No business tool impacts your company's image as powerfully as the right apparel, and Imagine It® provides the tools to set you apart from the competition.

*Decorate It. Modify It. **Customize It.***



EMBROIDERY

ACTIVITY: EL - EMBROIDER LOGOS / EH - EMBROIDER BALL CAPS

Embroidery is one of the first enhancements most customers look at when considering decoration of VF Workwear apparel. A logo announces to the world who you represent, and a strong first impression can make a big difference in business. Imagine It can handle all aspects of your embroidery needs. We offer a wide selection of thread colors shown on pages 11 - 13. If you need your logo digitized, we can handle that as well.



How to Request a Custom Logo

- **Contact Customer Service** for additional information on submitting new logo image artwork. 1-800-733-5271
- **Formats** - Acceptable formats for artwork of logo include: .TIF, .BMP, .JPG, or .EPS. Or, submit a previously digitized file (Tajima format preferred).
- **Color / Thread Limitations** - Custom logos are limited to 9 colors.
- **Size** - A typical left or right chest location is about 2 ½" x 3 ½". Small detail in a logo design may require resizing or an adjustment so that detail can be seen. See page 5 for size guidelines on garments and locations.
- **Timeline** - If required, please allow up to 3 days to receive a sew-off of custom logos. Logos in excess of 20,000 stitches may require longer.

Using the Online Interface

We are happy to work with you to have your logos loaded into our system under your customer account number. This will allow your logos to populate within the Imagine It interface screen to be utilized for online customization. Ask your VF Customer Service Representative for more information.



EMBROIDERY LOCATIONS

VF Workwear uses colorfast embroidery threads for all embroidery applications. These threads are also accepted by the industrial laundry industry. Using good laundry practices, as outlined in the “Red Kap Guide to Laundry Processing,” will produce acceptable results with industrial processed garments. Because end use and processing requirements will vary, laundering a sample is recommended to determine the specific guidelines that work best in your situation.

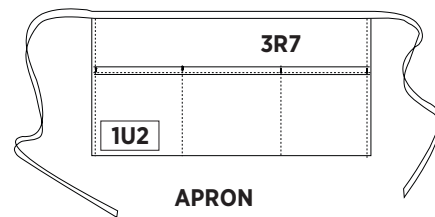
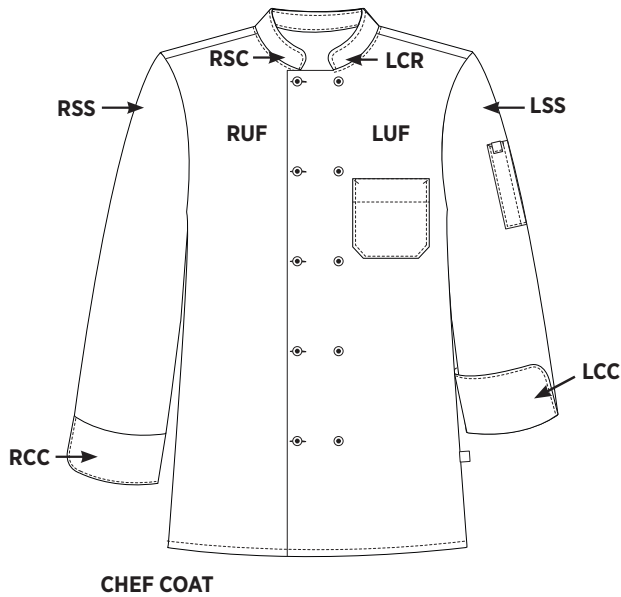
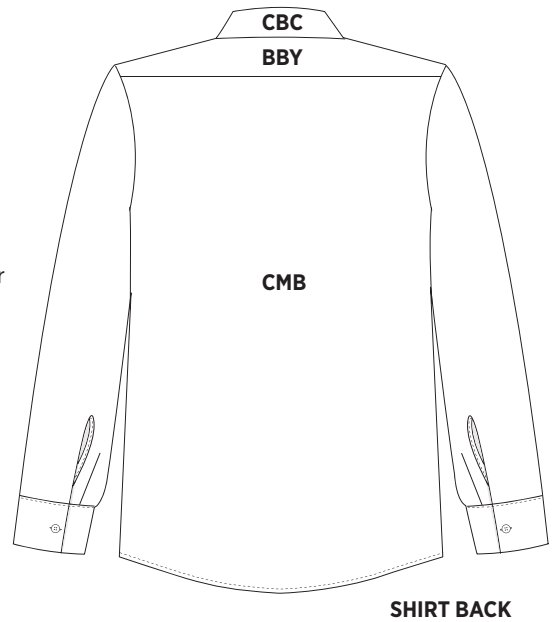
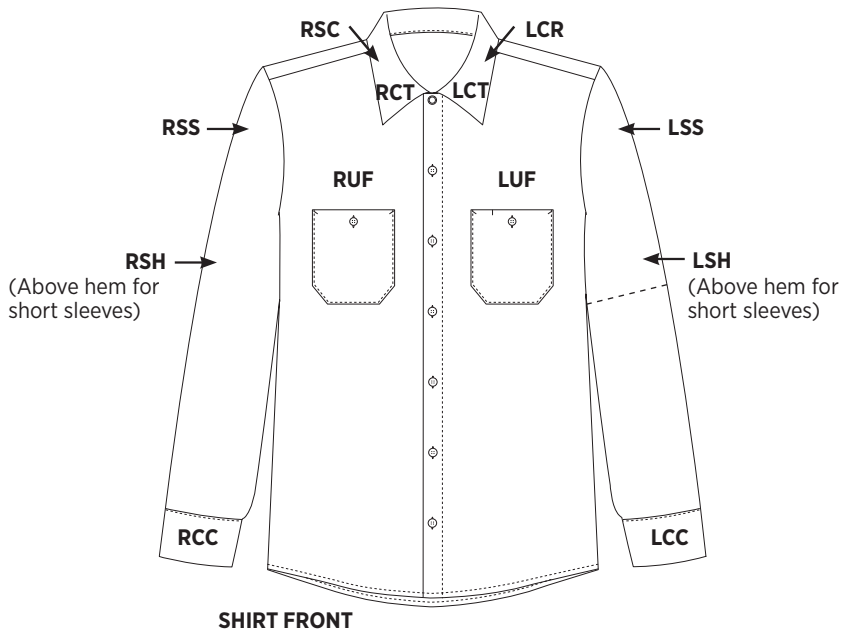

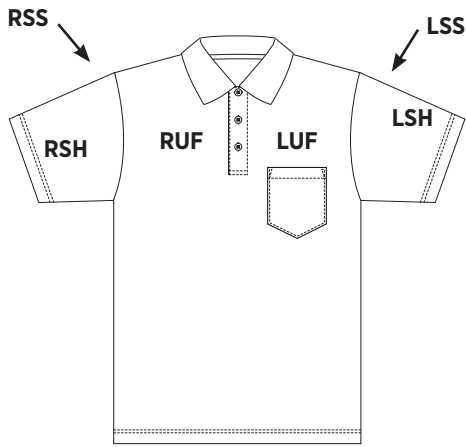

POLO FRONT



POLO BACK

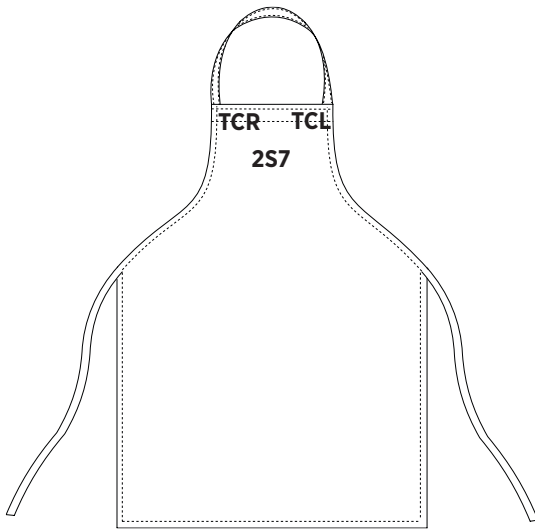

APRON

***USE ACTIVITY CODE: EH**

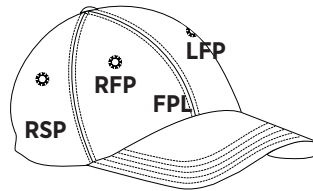

BALL CAP FRONT

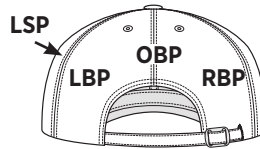

BALL CAP BACK

Embroidery Guidelines and Success Tips

- Placement and size can differ based on the garment they will be sewn on. These pages show placements and size guidelines for various garment types.
- To determine the best size and placement for embroidery, photocopy the logo to the desired size, cut it out and place it on the garment in various locations until the best size and location is determined.
- If grommets, eyelets or badges will be going on the same side of a garment as embroidery, be sure to leave the appropriate space for the badge when specifying embroidery location.

EMBROIDERY CODES WITH SIZE GUIDELINES

All sizes below listed as inches.

BBC - Back, 1" Below Collar	1x4
BBY - Back Yoke	1½ x 4
CBC - Center Back Collar	1x1
CMB - Center Middle Back	10x10
LCC - Left Cuff Centered	1x3
LCR - Left Collar at Side Centered	2x1
LCT - Left Collar Tip	1x2
LSH - Left Short Sleeve at Hem	4x4
LSS - Left Sleeve at Shoulder	4x4
LUF - Left Upper Front	4 x 4
RCC - Right Cuff Center	1x3
RCT - Right Collar Tip	1x2
RSC - Right Side Collar	1x1
RSH - Right Short Sleeve at Hem	4x4
RSS - Right Sleeve at Shoulder	4x4
RUF - Right Upper Front	4 x 4
TCR - Top Corner, Right	2x2
TCL - Top Corner, Left	2x2
1U2 - Centered on Right Pocket	2x2
2S7 - Middle Upper Front	3x3
3R7 - Left Upper Front - Apron	3x3

*EMBROIDERY CODES FOR BALL CAPS (EH)

Use activity code EH

*FPL - Front Panel, Cap	2¼ x 4
*LBP - Left Back Panel, Cap	1x1½
*LFP - Left Front Panel, Cap	1x1½
*LSP - Left Side Panel, Cap	1x1½
*OBP - Over Back Panel, Cap	1¼ x 4
*RBP - Right Back Panel, Cap	1x1
*RFP - Right Front Panel, Cap	1x1½
*RSP - Right Side Panel, Cap	1x1½

Don't see your location listed? Contact Customer Service. We have over 300 different embroidery locations across all garments, and one that will work for you.



STOCK EMBLEMS

ACTIVITY: AM

Whether adding an embroidered "name" emblem, or an American flag, or one of your own emblems we will attach them all with expertise. Emblems supplied by our customers are kept in a secured area and applied at the time of order allowing the customer flexibility to decorate their garments with a variety of emblem placements.



EM3323

American Flag with right star field and Gold Trim 3" x 1 7/8"



EMR037

American Flag with left star field and Gold Trim 3 1/2" x 2"

The US Department of Defense has this to say regarding the proper placement of the American Flag on uniforms.

"The regulation states that when authorized for application to the proper uniform the American flag patch is to be worn, right or left shoulder, so that "the star field faces forward, or to the flag's own right. When worn in this manner, the flag is facing to the observers right, and gives the effect of the flag flying in the breeze as the wearer moves forward. The appropriate replica for the right sleeve is identified as the "reverse side flag".

AMERICAN FLAG EMBLEMS

Lot #	Border	Star Field	Size
EHP016	White	Left	1 3/4" x 1"
EM2437	White	Left	3 1/2" x 2"
EMR037	Gold	Left	3 1/2" x 2"
EM3981	Gold	Left	3 1/2" x 2 1/2"
EMR1AF	Gold	Left	4" x 2 1/2"
EM3461	White	Right	3 1/2" x 2"
EM3323	Gold	Right	3" x 1 7/8"



EMBLEM EMBROIDERY

**ACTIVITY: EM - EMBROIDER & ATTACH
EE - EMBROIDER AND SELL LOOSE**

The same font selections and sizes shown on the following pages can also be applied to emblems. See page 9 for character limitations on emblems.

Font Size:
Shown Actual Size
5/8" 15 mm
7 characters per line

Small Emblem
Shown Actual Size

1 5/8"



3 5/8"

2 1/2"



4 1/2"

Large Emblem
Shown Actual Size

Font Size:
Shown Actual Size
5/8" 15 mm
10 characters per line



White, White Trim
Large: EMR2WW
Small: EMR1WW



White, Red Trim
Large: EMR2WR
Small: EMR1WR



White, Blue Trim
Large: EMR2WB
Small: EMR1WB



White, Navy Trim
Large: EMR2WN
Small: EMR1WN



White, Black Trim
Large: EMR2WK
Small: EMR1WK

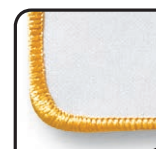

White, Yellow Trim
Small: EMFIGW

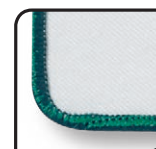

White, Green Trim
Small: EMFIGR



Grey, Black Trim
Large: EMR2GN
Small: EMR1GN



Light Green,
Green Trim
Large: EMR2GG
Small: EMR1GG



Tan, Black Trim
Large: EMR2TB
Small: EMR1TB



Royal Blue,
White Trim
Small: EMF1RB



Navy, White Trim
Large: EMR2NW



Black, Black
Large: EMR2BB
Small: EMR1BA

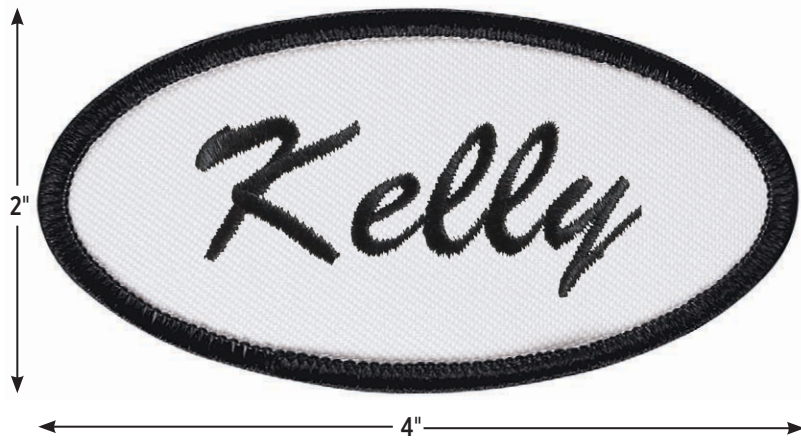

Oval Emblem
Shown Actual Size

Font Size:
Shown Actual Size
5/8" 15 mm
7 characters per line



White, Black Trim
EM01WK



White, Blue Trim
EM01WB

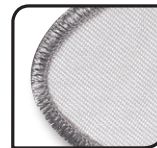

Grey, Charcoal Trim
EM01GC

DIAMOND PLATE EMBLEMS

(Small 1 5/8" x 3 5/8" / Large 4 1/2" x 2 1/2")

What could speak more directly to the automotive market than a diamond plate pattern? This design compliments any color shirt and is a winning combination with your name in the center.



Shown actual size (small)

Small: EM4002 Large: EM4108

STRIPED OPTIONS

(Small 1 5/8" x 3 5/8" / Large 4 1/2" x 2 1/2")

For those of you who prefer to wear striped or checked work shirts, several of our most popular styles are available with a fabric matching emblem for an upgraded look. (Stripe placement on emblem may not match exactly to stripes on shirt).



Shown actual size (small)

Approximate Character Limits for Small and Large Name Emblems

	B08	B12	B15	B18	B25
Small Name Emblem	11	8	7	5	4
Large Name Emblem	14	10	9	7	5
	S08	S12	S15	S18	S25
Small Name Emblem	15	9	8	6	n/a
Large Name Emblem	20	12	11	8	5
	R08	R12	R15	R18	R25
Small Name Emblem	11	7	6	5	3
Large Name Emblem	15	10	8	6	4
	T08	T12	T15	T18	T25
Small Name Emblem	14	9	7	5	n/a
Large Name Emblem	18	12	10	7	4

Note: Lettering that drops below the horizon line cannot be completed for two line application on S25 and T25 lettering on the large emblem.



For shirt SP10/20KB
Large: EM4103



For shirt SP14/24EX
Small: EM4000
Large: EM4106



For shirt SP10/20GI
Small: EM4001
Large: EM4107



DIRECT EMBROIDERY

ACTIVITY: ED

Four fonts are offered for direct embroidery, with several sizes in each (3/8" - 1"). Embroider text directly on a garment, an emblem, or on a name strip. This option is most often used for names, titles, accredits, etc. and can be done easily without the need for digitization.

- Multiple lines of type, in the same or different sizes, can be added to a garment. To add more than one line, please contact a Customer Service Representative at 1.800.733.5271 to order this option.
- Please specify if all CAPS are required. Using all caps will reduce the number of characters per line. The character counts listed below are based on lower case.

**Embroidery will be done in requested font/case/spelling.*



BLOCK
IMAGINE IT
Imagine It

22 characters per line	16 characters per line	14 characters per line
B08 3/8" 8 mm	B12 1/2" 12 mm	B15 5/8" 15 mm

Aa,Bb,Cc, Dd,Ee,Ff,Gg,Hh,Ii,Jj,Kk,Ll,Mm,Nn,Oo,Pp,Qq,Rr,Ss,Tt,Uu,Vv,Ww,Xx,Yy,Zz

ATHLETIC SWOOSH
IMAGINE IT
Imagine It

30 characters per line	19 characters per line	17 characters per line
S08 3/8" 8 mm	S12 1/2" 12 mm	S15 5/8" 15 mm

Aa,Bb,Cc, Dd,Ee,Ff,Gg,Hh,Ii,Jj,Kk,Ll,Mm,Nn,Oo,Pp,Qq,Rr,Ss,Tt,Uu,Vv,Ww,Xx,Yy,Zz

CENTURY MEDIUM
IMAGINE IT
Imagine It

23 characters per line	15 characters per line	13 characters per line
R08 3/8" 8 mm	R12 1/2" 12 mm	R15 5/8" 15 mm

Aa,Bb,Cc, Dd,Ee,Ff,Gg,Hh,Ii,Jj,Kk,Ll,Mm,Nn,Oo,Pp,Qq,Rr,Ss,Tt,Uu,Vv,Ww,Xx,Yy,Zz

BRUSH SCRIPT
IMAGINE IT
Imagine It

28 characters per line	18 characters per line	15 characters per line
T08 3/8" 8 mm	T12 1/2" 12 mm	T15 5/8" 15 mm

Aa,Bb,Cc, Dd,Ee,Ff,Gg,Hh,Ii,Jj,Kk,Ll,Mm,Nn,Oo,Pp,Qq,Rr,Ss,Tt,Uu,Vv,Ww,Xx,Yy,Zz

For information regarding availability of special characters, please contact a customer service representative.

All embroidery shown at actual size.

All fonts also available in 10mm (not shown). Call for more information.

- Include spaces and punctuation when counting characters per line.
- Collar tip and cuff embroidery locations require 8mm font and are limited to 3 characters.

BLOCK
IMAGINE IT
Imagine It

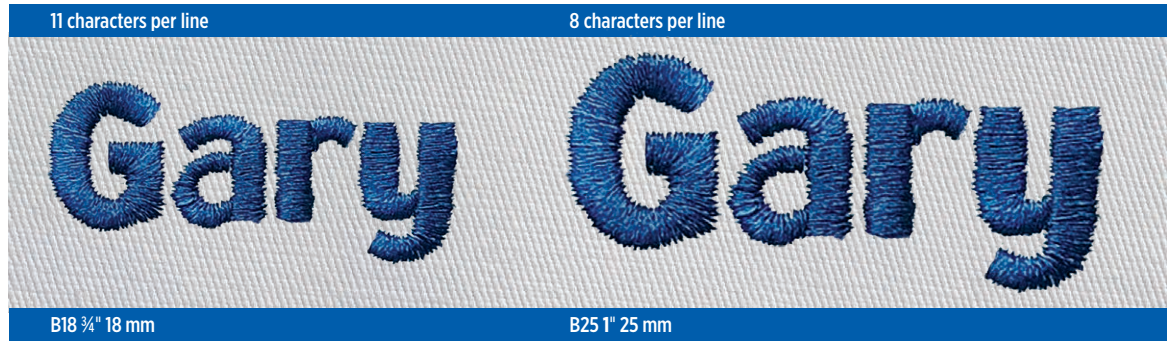

Aa,Bb,Cc, Dd,Ee,Ff,Gg,Hh,Ii,Jj,Kk,Ll,Mm,Nn,Oo,Pp,Qq,Rr,Ss,Tt,Uu,Vv,Ww,Xx,Yy,Zz

ATHLETIC SWOOSH
IMAGINE IT
Imagine It

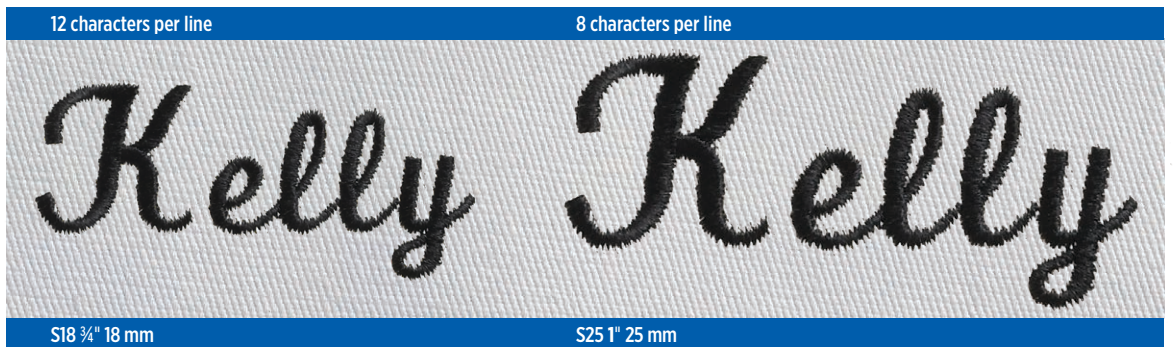

Aa,Bb,Cc, Dd,Ee,Ff,Gg,Hh,Ii,Jj,Kk,Ll,Mm,Nn,Oo,Pp,Qq,Rr,Ss,Tt,Uu,Vv,Ww,Xx,Yy,Zz

CENTURY MEDIUM
IMAGINE IT
Imagine It



Aa,Bb,Cc, Dd,Ee,Ff,Gg,Hh,Ii,Jj,Kk,Ll,Mm,Nn,Oo,Pp,Qq,Rr,Ss,Tt,Uu,Vv,Ww,Xx,Yy,Zz

BRUSH SCRIPT
IMAGINE IT
Imagine It

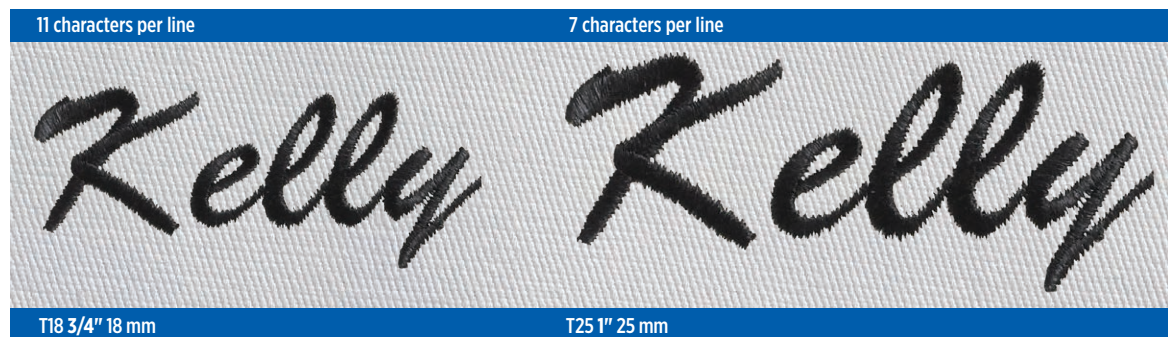

Aa,Bb,Cc, Dd,Ee,Ff,Gg,Hh,Ii,Jj,Kk,Ll,Mm,Nn,Oo,Pp,Qq,Rr,Ss,Tt,Uu,Vv,Ww,Xx,Yy,Zz

For information regarding availability of special characters, please contact a customer service representative.

THREAD COLOR OPTIONS

We will be happy to match your Pantone® supplied colors to American Efrid Signature thread. If a color cannot be matched we will contact you with alternative suggestions.

 WH - White 50081	 3G - Glow 50350	 DF - Daffodil 50087	 SU - Sunburst 50533	 2N - Antique Gold 50524	 8V - Pumpkin II 50737	 RD - MI Artillery 50018
 EE - Eggshell 50463	 V1 - Visor Gold 50566	 8J - Goldenrod 50364	 YE - Yellow 50532	 R8 - Rattan 50402	 OP - Orange Poppy 50565	 WF - Wildfire 50562
 XA - Ivory 50396	 8T - Gold 51354	 ST - Star Gold 50351	 LO - Toboggan 50751	 XC - Dark Khaki 50092	 8Q - Dk. Orange 50730	 MR - Garnet #2 50718
 IV - Ivory 50780	 G5 - Gold #23 50882	 LG - Liberty Gold 50026	 BN - Rancho Brown 50041	 XD - Chocolate 50411	 5K - Paprika 50370	 RT - Russet 50115
 XB - Champagne 50054	 8R - Khaki 50782	 GD - Royal Gold 50019	 PE - Penny 50386	 NU - Nutmeg 50635	 OR - Paprika #2 50600	 8E - Carolina Red 50147
 9X - Seashell 50408	 LA - Lemonade 50023	 4T - Marigold 50027	 MT - Gold (Metallic) 51000	 XE - Light Cocoa 50412	 SR - Spanish Red 50020	 D2 - Cranberry Crush 50617
 E6 - Off White 50091	 CN - Canary 50362	 MU - Mustard 50383	 9T - Copper 50378	 C6 - Brown 50414	 A8 - Terra Cotta 50394	 WN - Maroon 50465
 MS - Silver 51001	 1Y - Moon Beam 50522	 NE - Nector 50360	 XX - Brass Gold 50596	 BY - Burly Brown 50577	 E7 - Candy Apple 50082	 NM - Intense Maroon 50627
 EU - Ecru 50398	 9H - Sunflower 51533	 B7 - Butterscotch 50604	 8L - Gold 50555	 DB - Walnut 50042	 FX - Foxy Red 50141	 PK - Perisan Rose 50021
 TP - Taupe Beige 50039	 FL - Fluorescent Yellow 50024	 9N - Butter 50521	 OD - Old Gold 50860	 RS - Rust 50377	 CR - Maraschino 50059	 RR - Radiant Red II 50810
 8B - Beige 50008	 YL - Mimosa 50025	 9W - Marigold 52416	 8P - Honey Gold 50642	 P4 - Pumpkin 50367	 8D - Scarlet 50074	 PS - Passion 50261

THREAD COLOR OPTIONS CONTINUED...

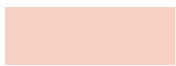

BQ - Bisque
50155



GA - Grey #1
50442



XZ - Dover Grey
50451



5J - Indian Sky
50034



SL - Slate Blue
50181



DR - Dark Royal Blue
50643



TL - Hornets Teal
50028



ZP - Pink
50101



GR - Heather Grey #2
50760



SV - Silvery Grey
50448



H2 - Boo Boo Blue
51712



XN - China Blue
50194



BB - Blueberry #2
50722



AV - Aqua Velva
50628



LV - Cachet
50048



NC - New Cinder
50879



BA - Banner Grey
50447



RY - Royal Blue
50735



8N - Alexis Blue
50638



5N - Lt. Navy
50816



AZ - Azure
50017



3P - Plum
50263



GY - Western Grey
50046



XI - Silver Speed Grey
50689



JB - Jay Blue
50222



BE - Blue
50223



NL - Lt. Navy
50006



XO - Imperial Aqua
50581



9E - Plum
50540



A3 - Twilight
50455



LB - Ice Blue #2
50719



8S - Blue
50785



RL - Royal Blue
50088



CD - Cadet Navy
50640



XP - Isle Green
50551



PR - Dk Purple #2
50756



LY - Lt. Grey
50073



XJ - Sky Blue
50055



PO - Peacock
50727



8Z - Bright Blue
50058



D1 - Dark Navy
50517



GG - Mint Tint
50013



A4 - Purple Shadow
50250



WG - Whale Grey
50490



XM - Vibrant Chicory
50606



8F - Copen
50221



EM - Empire Blue
50227



VG - Very Dark Grey
50647



A6 - Pistachio
50289



DP - Deep Purple
50768



1W - Metal
50454



MB - Blue 1
50031



EB - Empire Blue
50035



RB - Blue Bird
50032



BL - Black
50064



XQ - Pastoral Green
50313



XG - Easter Purple
50654

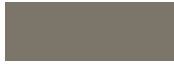

XH - Pewter
50436



XL - Oriental Blue
50220



PC - Pacific Blue
50186



C3 - Royal
50190



TQ - Turquoise
50531



F6 - Spruce
50296



8K - Purple Twist
50548



LT - Wheat
50602



BD - Blue Dawn
50569



PB - Danish Teal
50029



TR - True Royal
50539



CA - Cool Aqua
50051



8G - Erin Green
50299



PW - Port Wine
50246



SS - Sterling
50097



XK - Blue Sky
50090



1B - Blue Grey
50731



9L - Salem Blue
50204



AQ - Aqua
50016



5M - Green Radiance
50806

THREAD COLOR OPTIONS CONTINUED...



GN - Bright Green Neon
50765



GS - Green Grass
50308



EV - Evergreen
50534



9U - Peapod
50312



XT - Green
50619



SG - Spruce #1
50014



8H - Crescent Moon
50331



8A - Brt. Evergreen
50005



SW - Swamp Gator
50660



S6 - Sage
50320



5L - Celtic Green
50664



2M - DH Green #2
50694



XS - Moss Green
50523



9V - Sage
51702



BG - Bagby Green
50040



RG - Irish Green
50513



OL - Olive Drab
50290



A1 - Scotty Green
50078



4V - Olive Drab
51131



9G - Holly
51671



8U - Bright Green
50738



SH - Shamrock
50595



KG - Emerald #1
50012



SM - Spanish Manchu
50072



K3 - Kelly Green
50303



DG - Forest Green
50015



REFLECTIVE STRIPING

Enhanced visibility can be critical when working in high-traffic areas, on construction sites or around equipment operation. Adding reflective striping to your uniform can make a life-saving difference. Select from the many trim widths, colors and placements to make your enhancements have the highest impact. These distinctive stripings can be added to most garments. Flame-resistant striping is also available. The garments and striping you select should depend on the end use requirements.

With a few exceptions, stripes shown above the waist can be applied to a shirt, jacket or coverall. Stripes shown below the waist can apply to a pant, short, or coverall. The specific details of a garment, like the size of a pocket, the placement of closures, an emblem or an additional pocket, may dictate a slight change in the placement from what is shown in these images.

- Striping applied post-manufacturing will always go around a pocket or emblem. Pockets cannot be removed for reflective trim application.
- Stripes on a waistband will be moved up or down if the waistband has elastic sections.

ST52SV



PC20NV



REFLECTIVE STRIPING LOCATIONS

STRIPE CODES	LOCATION DESCRIPTION	FRONT	BACK
HUF	Horizontal Upper Front	•	
STS	Shoulder to Shoulder		•
HUB	Horizontal Upper Back		•
DHB	Double Horizontal Back		•
BSB	Both Sleeves Bicep	•	•
HUP	Horizontal Under Pockets	•	
LMB	Lower Mid Back		•
AAC	All Around Coverall	•	•
BSF	Both Sleeves Forearms	•	•
JWB	Jacket / Coverall Waistband	•	•
LSC	Long Sleeve Cuff	•	•
BLT	Both Legs Thigh	•	•
PLK	Pant Leg Knee	•	•
BLC	Both Legs Calf	•	•
PLC	Pant Leg Cuff	•	•

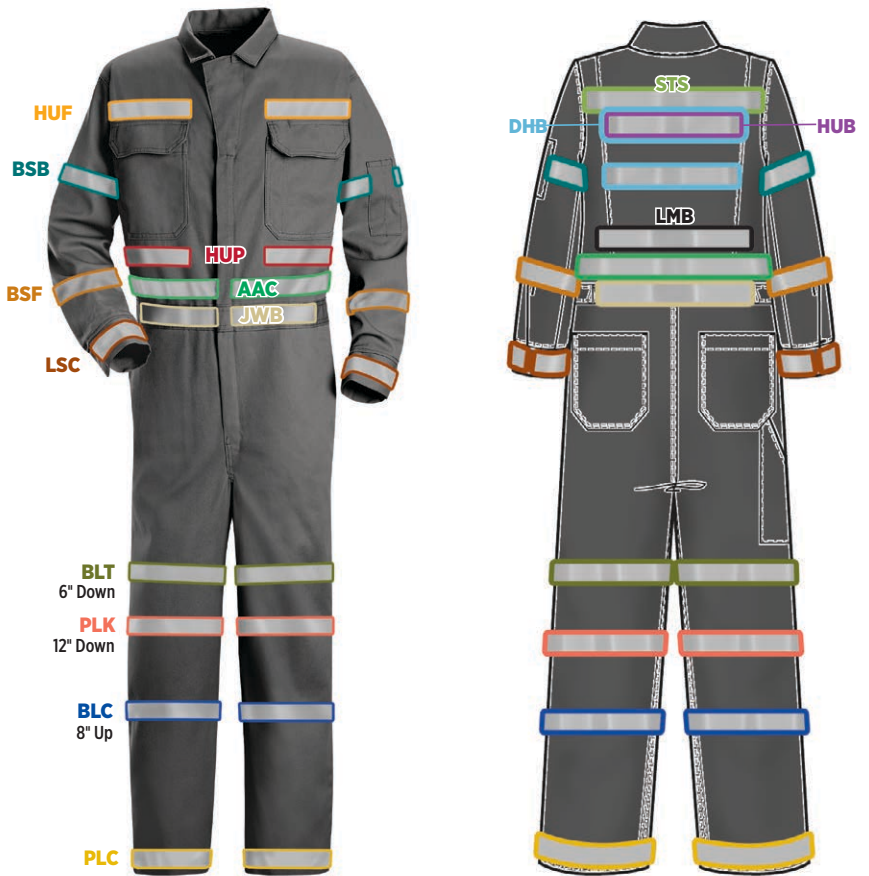

REFLECTIVE STRIPING LOCATIONS

STRIPE CODES	LOCATION DESCRIPTION	FRONT	BACK
SUS	Around Waist, 2 pieces Over Shoulders and 2 pieces under pockets	•	•
SSC	Short Sleeve Cuff	•	•



ANSI Compliant Striping

The stripe configurations shown here are not necessarily ANSI compliant. To provide guidance for the protection of all those exposed to the hazards of limited visibility, the American National Standards Institute, Inc. (ANSI), approved ANSI/ISEA 107-2015, the American National Standard for High-Visibility Safety Apparel. ANSI/ISEA 107-2015 establishes design, material, photometric and physical performance requirements, care labeling and marking rules for high visibility garments.

End users should conduct a hazard assessment in order to select garments with the proper type, class and design placement for their work environment. Please refer to ANSI/ISEA 107-2015 for further information.



REFLECTIVE STRIPING LOCATIONS

STRIPE CODES	LOCATION DESCRIPTION	FRONT	BACK
LST	Long Sleeve Shoulder to Cuff	•	•
FXB	Full X Back - OK with suspenders		•
UPV	Under Pocket to Waist	•	
OSW	Side Seam to Waist	•	•



REFLECTIVE STRIPING LOCATIONS

STRIPE CODES	LOCATION DESCRIPTION	FRONT	BACK
SUP	Around Waist and 2 pieces Over Shoulders	•	•
CBX	Center Back X-12" stripes		•
SST	Short Sleeve to Hem	•	•
AAS	All Around Shirt	•	•



Reflective Striping Packages

Many package options already exist for various stripe configurations on shirts, jackets, coveralls, and pants. Contact a (CSR) Customer Service Representative for the stripe combination you are looking for, or peruse the next several pages for some of the most frequently purchased package configurations.

REFLECTIVE STRIPING PACKAGES

Many package options for reflective striping already exist for shirts, jackets, coveralls and pants. On the next several pages we're showing a collection of the most popular packages to help identify one that will work for you. As a package these applications will carry a lower overall price than the individual locations ordered together.

PANTS / COVERALLS

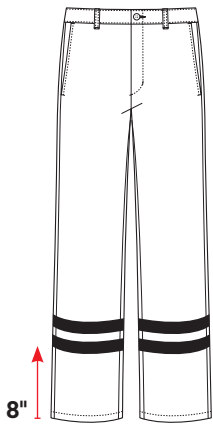

DM7

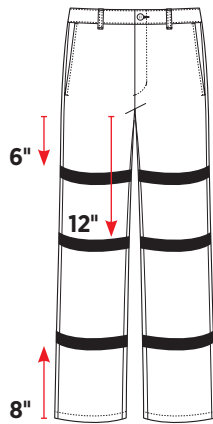
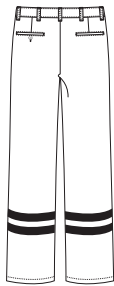

D98

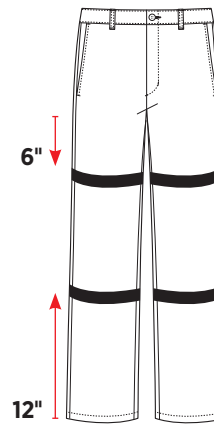

DLK

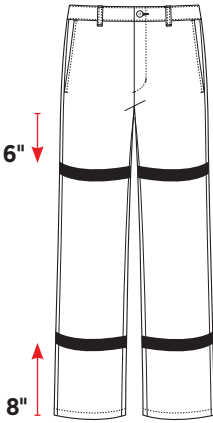

DB2

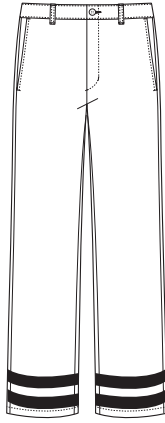

D75

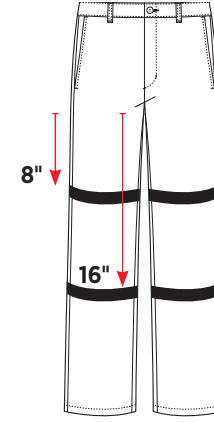
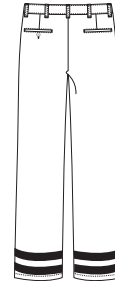

DP3

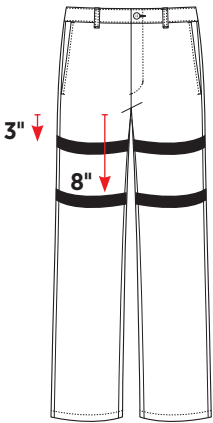
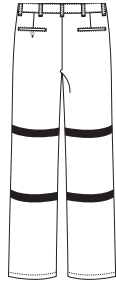

DL2

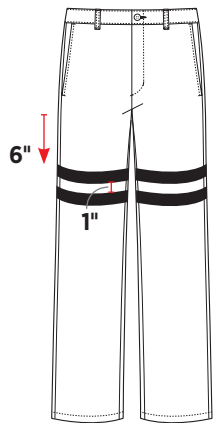
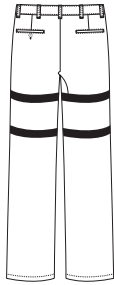

DD4

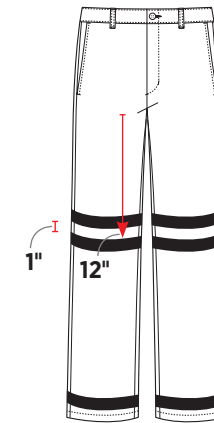

D30



All illustrations are shown on generic garment images.

SHIRTS / COVERALLS / JACKETS

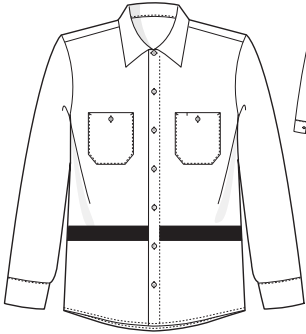

ASL



D13



D71



D56



DB6



DB7



D96



DA5



DB8



Inquire with your customer service representative if you need specific information or measurements on any of the packages shown. ANY changes to what is shown here will constitute a new package and a new price.

All illustrations are shown on generic garment images.

SHIRTS / COVERALLS / JACKETS CONTINUED...



DC7

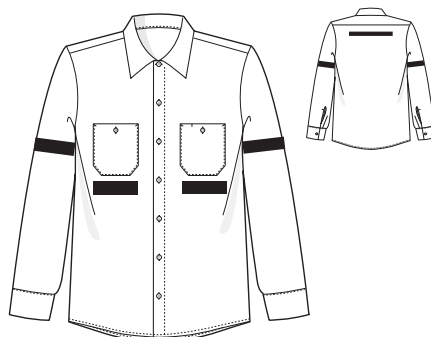

DN3



D93



DE2



DU3



DL5



DQ4



FOR



FXO

All illustrations are shown on generic garment images.

COVERALLS

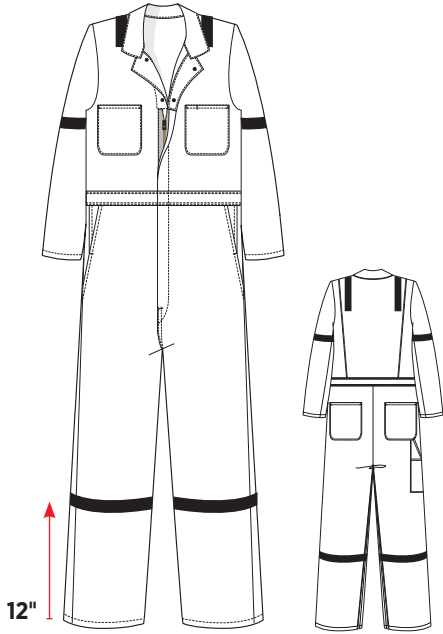

D35

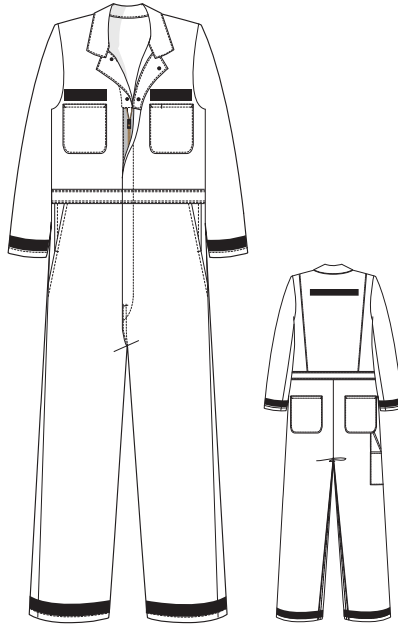

LPF

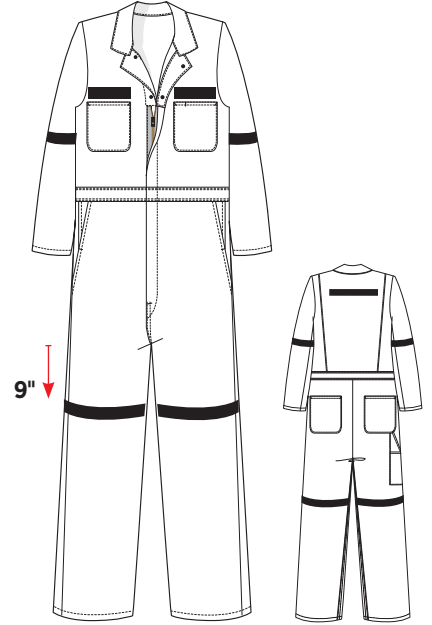

D92

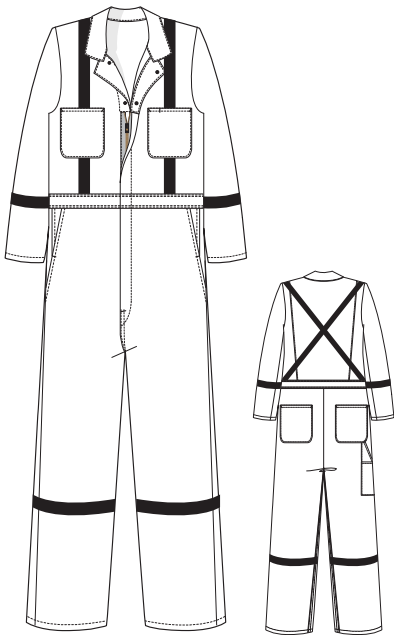

D36

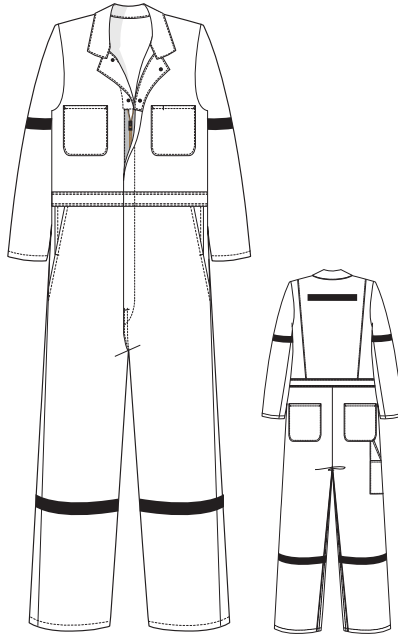

DY8

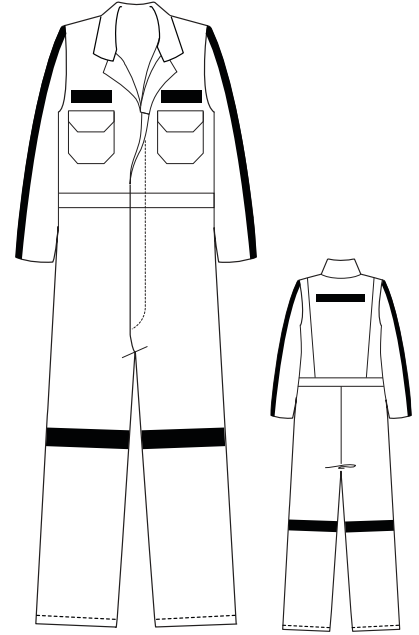

DQ1

All illustrations are shown on generic garment images.

COVERALLS CONTINUED...

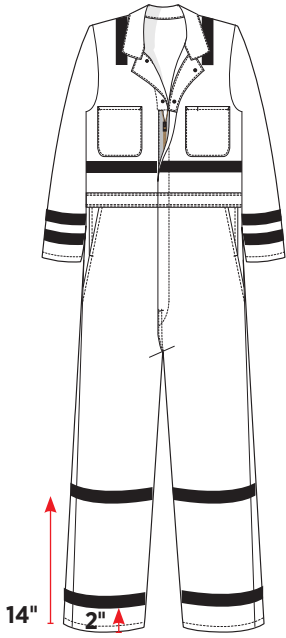

DC4

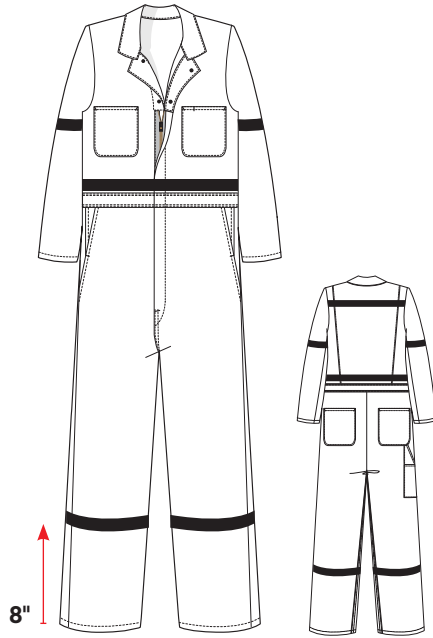

DN6

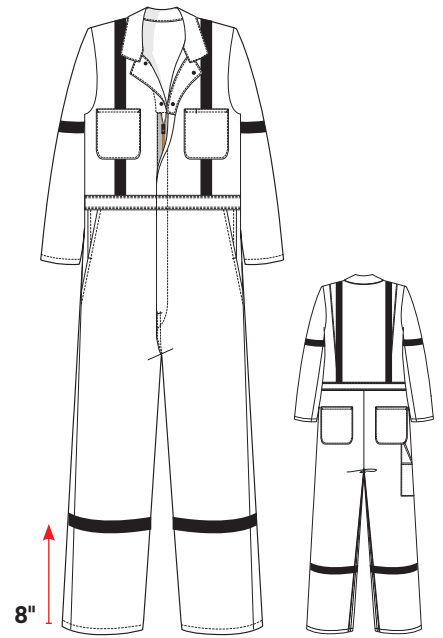

DK8

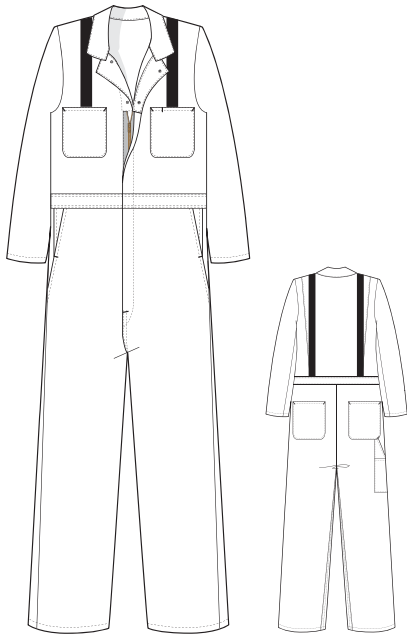

SFB

Additional packages

If you don't see what you are looking for on these pages, additional packages are available to view on-line. Go to vfimagewear.com and, after logging in, click on the "Reflective Striping" heading. Images will be located under three categories: tops, bottoms, and coveralls. The three-digit code shown with each drawing is the location code for ordering that configuration. Submit that along with the two-digit activity code, found on pages 22 and 23 and you're ready to order.

All illustrations are shown on generic garment images.

REFLECTIVE TRIM

There are several color options and widths of reflective trims that can be selected for attachment to your garments. Ours are divided into four categories: FR – Industrial Wash, FR – Home Wash, Industrial Wash, and Home Wash. Many stripe styles are available in one or more of these categories; however, prices will vary depending on the trim and locations selected. Please be sure to select the correct trim.



FR / IL - FLAME RESISTANT / INDUSTRIAL LAUNDRY FRIENDLY



Activity: **S1** Component: EH5215 Description: 1" Silver ▲



Activity: **1J** Component: EH3207 Description: 2" Silver ▲



Activity: **4B** Component: ESRTOR Description: 2" Orange/ ¾" Silver/Orange ▲



Activity: **1B** Component: EH5283 Description: 2" Yellow/ ¾" Silver/Yellow ▲



Activity: **Y4** Component: EH5208 Description: 2 ½" Yellow/ 1" Silver/Yellow ▲
Wash in Light Soil Formula



FR / HW - FLAME RESISTANT / HOME WASH



Activity: **S2** Component: EH5216 Description: 2" Silver ▲



Activity: **O1** Component: EH5210 Description: 1" Orange ▲



Activity: **Y1** Component: EH5203 Description: 1" Yellow ▲



Activity: **1N** Component: EH5204 Description: 2" Yellow ▲



Activity: **Y3** Component: EH5207 Description: 2" Yellow/ ¾" Silver/Yellow ▲

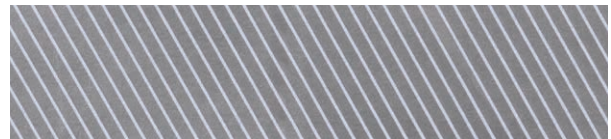

Activity: **HT** Component: EH3321 Description: 2" Segmented Silver ▲

(NOT SHOWN ACTUAL SIZE)



Codes with red symbols indicate reflective trims are (FR) flame-resistant.



IL - INDUSTRIAL LAUNDRY



Activity: **4C** Component: **EH5279** Description: **½" Silver**



Activity: **1P** Component: **EH5277** Description: **1" Silver**



Activity: **G2** Component: **EH5276** Description: **2" Silver**



Activity: **1K** Component: **EH5430** Description: **1 ½" Yellow/ ½" Silver/Yellow**



Activity: **3N** Component: **EH5221** Description: **2" Yellow/ ¾" Silver/Yellow**



Activity: **1E** Component: **EH5282** Description: **2 ½" Yellow/ ½" Silver/Yellow**



Activity: **4M** Component: **EH5284** Description: **2 ½" Yellow/ 1 ½" Silver/Yellow**



Activity: **OV** Component: **EH5280** Description: **1 ½" Orange/ ½" Silver/Orange**



Activity: **1Q** Component: **EH5278** Description: **2 ½" Orange/ ½" Silver/Orange**

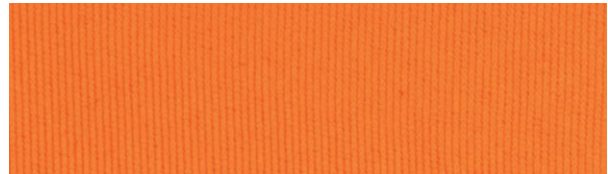

Activity: **1C** Component: **EH5336** Description: **2 ½" Orange**

(NOT SHOWN ACTUAL SIZE)

HW - HOME WASH



Activity: **GV** Component: **EH5226** Description: **1" Silver**



Activity: **1O** Component: **EH5225** Description: **2" Silver**



Activity: **YV** Component: **EH5281** Description: **1 ½" Yellow/ ½" Silver/Yellow**

(NOT SHOWN ACTUAL SIZE)



EPAULETS AND POCKET FLAPS

ACTIVITY: AE - ADD EPAULETS / FM_LRE - REPLACE EPAULETS
AF - ADD FLAPS / FM_LRF - REPLACE FLAPS

Epaulets and pocket flaps can quickly turn a generic garment into one that speaks directly to a specific job function. Whether using contrasting color combinations or matching trims these shirts can dress employees from security to parking attendants, bellmen and doormen.



BROWN - CB



WHITE - WH



SPRUCE GREEN - SG



RED - RD



BLACK - BK



NAVY - NV



CHARCOAL - CH



GREY - LA

Epaulets are attached at sleeve set seam and end 1" from the collar band.

Fabrics are 65/35 poplin and match the fabrics and colors of our SP14 industrial workshirt.

Epaulet Size Chart

FOR SHIRT SIZE	ORDER COMPONENT LOT NUMBER	2 DIGIT COLOR #
S, M, L, XL	EERL	as indicated under images
2XL, 3XL and up	EERT	as indicated under images

For example: If you want red epaulets added to an XL shirt, order EERLRD.

Epaulets are sold with matching plastic buttons.

HEX POCKET FLAPS



Available in two sizes.

Large Hex Pocket Flaps - 5 3/4" x 2 1/4"

LOT #	2 DIGIT COLOR CODE	SHIRT TYPE
EFRU	CH (charcoal), RD (red)	Dress Shirts

Small Hex Pocket Flaps - 5 1/4" x 2 1/8"

LOT #	2 DIGIT COLOR CODE	SHIRT TYPE
EFRW	RD (red), NV (navy), BK (black)	Work Shirts

Charcoal - CH (EFRU Only)



Red - RD (Both)



Black - BK (EFRW Only)



Navy - NV (EFRW Only)



EPAULETS AND POCKET FLAPS

**ACTIVITY: AE - ADD EPAULETS / FM_LRE - REPLACE EPAULETS
AF - ADD FLAPS / FM_LRF - REPLACE FLAPS**

Select from many color options to upgrade your shirts with contrasting pocket flaps and epaulets. Available in solid shades, these options can make your uniforms command attention and be noticed.

The shirt below shows other customized options that can be added to your shirt. Modify your garments to fit your specific needs.



COLLAR EYELETS
Code: EV_LRC



BADGE TAB - METAL EYELETS
Code: BT + Location



UPGRADED EPAULET
Code: FM_LRE



NAMEPLATE PATCH
Code: 4D_RUF



UPGRADED POCKET FLAP
Code: FM_LRF

PLAIN

- Black EFBK21
- Pink Tan EF0040
- Dark Navy EF0039
- Brown EFSB23
- Spruce Green EFSG28
- Forest Green EF0193

PLAIN

- Black EE0041
- Pink Tan EE0042
- Dark Navy EE21DN
- Brown EE22SB
- Spruce Green EE28SG
- Forest Green EE0040



PANT STRIPES AND HEMS

Get a leg up on the competition by adding a distinctive stripe to any pair of pants and attain uniform excellence when coordinating them with our distinctive selection of shirts and shirt trims. The 1" stripes shown here can stand on their own or be teamed with a second layer to create a piggyback stripe. Or, choose bias workwear stripes like the one shown on the brown pant, in ½" widths.



- A.** 1" stripe with second layer
Code: AS_OSW_+ components
- B.** ¾" stripe
Code: AS_OSW_+ component
- C.** ½" bias stripe
Code: 3B_OSW_+ component



WE'LL GO TO ANY LENGTH TO HELP YOU ACHIEVE THE LOOK YOU WANT

Whether it's capris or bermudas, straight lengths or cuffed hems, we'll customize your pants to fit your needs no matter what the climate or fashion demands.

Available hems: Pants will be hemmed to the desired inseam length with the designated hem for that pant. VF Workwear hem pricing rules apply. Other hem types are available for an additional charge. These must be ordered through a Customer Service Representative.

- A.** 12" long Bermuda short | Code: HH_L12
- B.** 15" long - just below the knee | Code: HH_L15
- C.** 23" Capri length - 21" (short) and 25" (long)
Code: HH_L23, HH_L21, HH_L25
- D.** Full length standard hem up to 36" in length.
No customization codes needed.
- E.** Cuffed Dress Pant | Code: CP_ up to L33 ½". Cuff depth is 1 ¼"

ATTACH POCKETS

ACTIVITY: AP

ROUTE POCKET



8 oz. Twill Fabric - Matching all same weight pant styles

LOT #	2 DIGIT COLOR CODE	FABRIC WEIGHT
EP8L	+ color code	8 oz. Pant



Example of a route pocket added to a pair of Charcoal pants. See additional color options to the right.

Black - BK

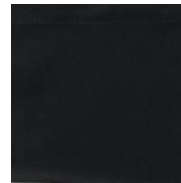

White - WH



Charcoal - CH



Navy - NV

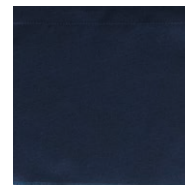

Royal Blue - RB

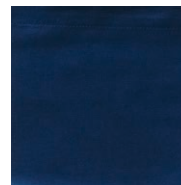

Grey - GY



Khaki - KH



Not all pant fabrics/colors have matching pockets available for customization.

CUSTOMIZED PANT POCKETS

ACTIVITY: AP

At Horace Small®, functionality can be built right in at the time you need it.

Custom pockets and placements are available to meet your specific needs. Consult with your Customer Service Representative to find out about your options, or select from the images below.

**GENERIC IMAGES DETAILS MAY VARY*

FRONT POCKETS

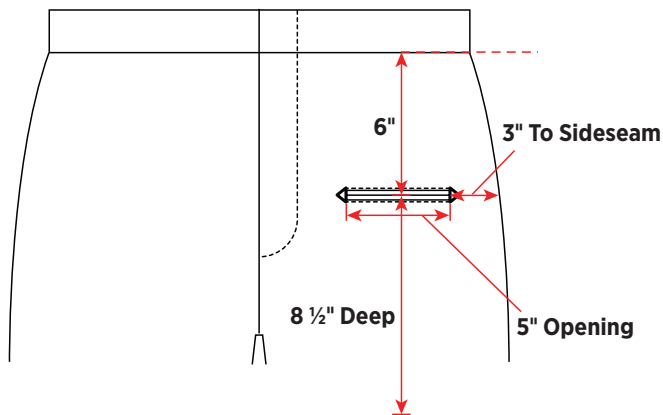

TWISTER POCKET

Use locations LPP and RPP

SIDE SEAM POCKETS

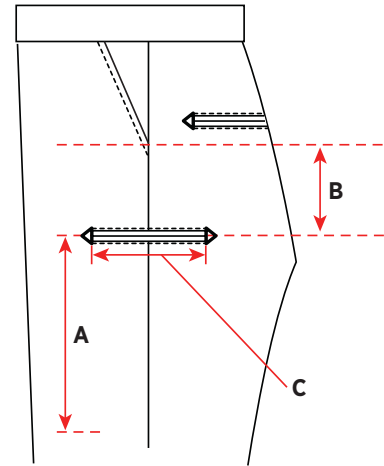

BILLY POCKET - SIDE LOCATION (BILLY ON SIDE SEAM)

Use locations RLS and LLS

A - 8" Deep

B - 3 1/2" Below front quarter top pocket

C - 3 1/2" Opening

ROUTE POCKET (INTERNAL POCKET)

Use locations RLS and LLS

A - 7 1/4" Deep

B - 3" Below front quarter top pocket

C - 6" Opening

BACK POCKETS

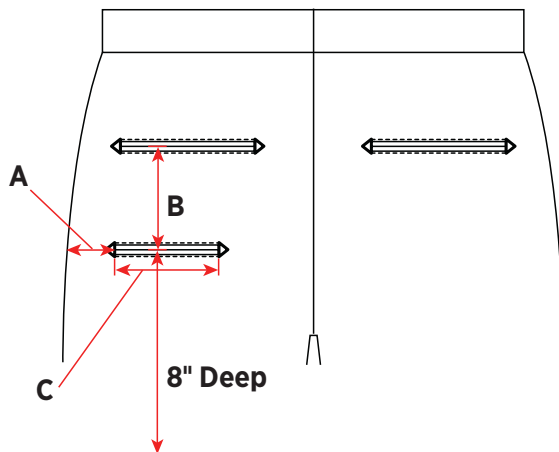

BILLY POCKET - SAP LOCATION

Use locations SPL and SPR

A - 2" (to side seam)

B - 6" Below hip pocket

C - 3 1/2" Opening

BILLY POCKET - BACK LOCATION

Use locations BLP and BRP

A - 1 1/2" (to side seam)

B - 3 1/2" Below hip pocket

C - 3 1/2" Opening



TROUSER STRIPES

ACTIVITY: AS

Add a distinctive stripe to any pair of trousers and attain uniform excellence when coordinating them with our selection of shirts and shirt trims. Choose from 3 widths of trims shown below for your specific uniform needs.



Soutache*
(See page 42 for available soutache colors.)

1/2" Stripe

3/4" Stripe

1" Stripe

TROUSER STRIPE & BRAID WIDTHS

(shown actual size)



1/2"



3/4"



1"

NYLA TWIST BRAIDS

ACTIVITY: AN



Black

EN0013 1/2"
EN0054 3/4"
EN0014 1"



Royal Blue

EN0028 1/2"

TROUSER STRIPE COLORS



Black

ES34BK 3/4"
ES01BK 1"



Brown

ES01BR 1"



Charcoal Grey

ES0552 1"

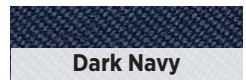

Dark Navy

ES0084 1/2"

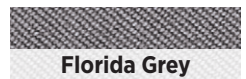

Florida Grey

ES0252 1/2"
ES0282 3/4"



French Blue

ES12FB 1/2"



Lapis Blue

ES0060 1/2"



Silver Tan

ES12ST 1/2"
ES01ST 1"



Yellow Gold

ES01YG 1"



ADDITIONAL CUSTOMIZATION OPTIONS

There are many additional customization options and services that we offer our customers. Many of these are not shown on the previous pages and are listed here for your consideration. Your Customer Service Representative can supply you with additional information on any of these options.

ACTIVITY CODE	OPTION NAME
2C	Replace Buttons - Metal Options
2I	Change Sleeve length
AA	Blank ID Label
AL	Add Sewn Label
AR	Add Buttons & Button hole
AV	Attach Hook and Loop
AW	Attach Radio Pocket
AZ	Attach Zipper - (Pants & Coverall Leg, Shirt Placket)
BT	Badge Tab
CP	Cuff Pants
CU	Attach Knit Cuffs
EV	Sewn Eyelets
IM	Attach ID Chip - (Customer Supplied)
KC	Replace Buttons - Plastic Options
KN	Remove Collar for a Banded Collar Look
LD	Cut & Hem Bottom of Garment
LT	Lintrak - Silicone Crease - (Horace Small Only)
MB	Make Button Holes various placements
PW	Add Covered Placket
RE	Remove Emblem/Label
RM	Remove Item (Buttons, Zippers, Epaulets)
SE	Reinforce Metal Button
SK	Silk-Screen Logo
SL	Silk-Screen Lettering
SP	Sew Locations Closed
TM	Apply Heat TR Logo/Emblem
ZM	Attach Maternity Knit Panel
ZZ	Attach Heatseal ID Label



BUTTONS

ACTIVITY: KC - CHANGE OUT TO PLASTIC BUTTONS / 2C - CHANGE OUT TO UPGRADED METAL BUTTONS

Looking for better closure? You're bound to get it when choosing from our distinctive collection of buttons. Add a touch of class to any uniform by exchanging existing buttons for upgraded metallic options in different finishes. Add color and zing to a chef's coat by replacing white buttons with color versions. A single upgrade like this will go a long way toward achieving a look that will have your employees proud to be in uniform.

As shown in the images here, consider customizing your garment by changing out **some** of the buttons where possible. One option is to upgrade buttons to gold or silver on the pocket flaps and epaulets of security shirts, allowing the front buttons to remain white. Changing buttons on a basic chef coat can take it from the kitchen to a presentation coat.



Colored Plastic Buttons



Royal Blue
EB1444 - 30L



Navy
EB1442 - 30L



Red
EB1440 - 30L

Metal Button

Gold Plain



EB0078 - 24L

Public Safety Buttons



Police Department



EB0011 - 24L



EB0036 - 24L
EB0038 - 36L

Fire Department



EB0009 - 24L
EB4068 - 36L



EB0013 - 24L
EB0046 - 36L

Sheriff's Department



EB0010 - 24L



EB0012 - 24L

BUTTONS

The metallic buttons available for upgrades to Workwear products are shown here. Available sizes are shown under each button. Select from various designs in gold or silver, or colored plastics.

Metallic Buttons - Home Wash or Dry Clean

Plastic Buttons - Industrial Laundry, Home Wash or Dry Clean

We can also store and apply customer-supplied buttons. Contact a CSR for more information.

MATERNITY PANT CUSTOMIZATION OPTION

ACTIVITY CODE: ZM / LOCATION CODE: CMF



MADE FOR USE WITH:

**RED KAP Dura-Kap® Women's Industrial Pant
Lot# PT21 - All Colors**

**HORACE SMALL Sentry Trousers for Women
All Colors**

Since most relevant features are cut away from the pant when the maternity version is created, it is recommended to use these basic pant Lot numbers for the most cost effective options. Other base lots can be used when necessary, and may need to be set up as we go.

MATERNITY PANEL:

FABRIC: 8.3 oz. Stretch Knit

BLEND: 65% Rayon, 29% Nylon, 6% Spandex

CARE: Home Wash

COLOR: Black Only

CLOSURE: 1/2" Comfort Elastic all around waist

FOR PANT SIZE	COMPONENT LOT NUMBER	PANEL COLOR
2,4,6	EMPS06	Black only
8,10,12	EMPM12	Black only
14,16	EMPL16	Black only
18,20,+	EMPX20	Black only

Price: \$25.00 USD / OTS: 12/01/2017



(shown on PT21)

Changes/Upgrades from previous maternity panel:

- Panel is a two piece design that replaces front and back sections of the woven pant
- Two piece construction brings stretch and ease to the back, as there is no woven constructed waistband causing discomfort
- Front panel is longer, so it covers the belly and has enough fabric to expand as the pregnancy moves to full term
- Softer, 1/2" comfort elastic won't constrict or bind
- Heavier, softer, 4-way stretch fabric is comfortable and secure on the body while remaining breathable

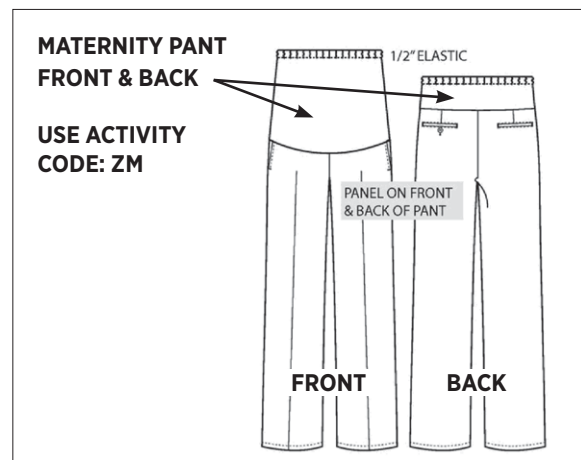

Illustrations are shown on generic garment images.

PULLING IT ALL TOGETHER

DECORATIVE TRIMS

From ribbon to soutache or middy braid, there are many available options when it comes to customizing collars, cuffs, and shirt fronts. Just a touch of silver or an edge in red can make an image statement that's hard to forget. After all, isn't that the impression we're all trying to make? Shown here are a few of the many possibilities. Over the next several pages, we'll give you a great start to formulating your own ideas as to

how you can take your image to another level! The images on the following pages were created to assist you in visualizing trim placements on a variety of garments. If you have any questions, call your Customer Service Representative at 1.800.733.5271, and they will assist you in placing an order. These images DO NOT show all available options and are not available on all products.



Above, Chef Coat shows: **Buttons:** KC_FB8 | **Pocket Trim:** KJ_PH1 | **Logo Embroidery:** EL_LUF

Left, Shirt & Jacket show: **Chest Trim:** 2F_HU2 | **Long Sleeve Trim:** 2M_2G3 | **Logo Embroidery:** EL_LUF

Above Left, Apron shows: **Logo Embroidery:** EL_2S7

AUTOMOTIVE SHIRTS / JACKETS



AUTOMOTIVE SHIRTS / JACKETS CONTINUED...

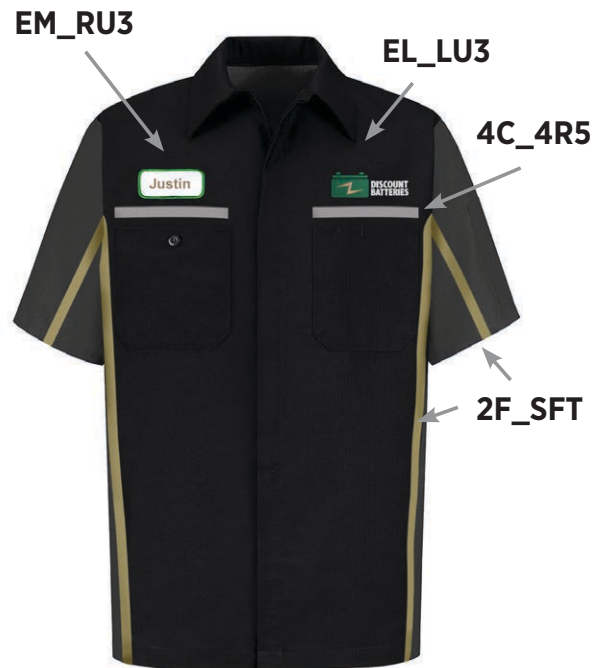

AUTOMOTIVE SHIRTS / JACKETS CONTINUED...



NEW! HI-VIS REFLECTIVE SEGMENTED TRIMS

ACTIVITY CODE: 2S / LOCATION CODE: Various (see next page for details)

The reflective and segmented portion of this 3M trim has been adhered to a 100% polyester grosgrain trim in a selection of great uniform friendly colors to enhance your garments. Sewn in locations that you've chosen at time of order, they will take automotive apparel, or industrial workwear, and give it a whole new look and feel. A great way to incorporate both color and reflectivity with one selection. *Garments decorated with these trims would not be compliant with any industry reflective standards.*



SK96RD

JP68BK

JP68BK
(back)

Examples shown with either:
EH0581 (Red/Silver segmented trim);
 or
EH0580 (Black/Silver segmented trim).

See next page for all color options.

*Garments are examples only.
 Contact a Customer Service
 Representative for more options.*

PT88BK

SP28BG

SP14GY

HI-VIS REFLECTIVE SEGMENTED TRIMS CONTINUED...

Decorate your uniforms by adding both color and reflectivity with one activity.



SP18CB /
EH0580 (trim)



SY20BC /
EH0582 (trim)



SK96GY /
EH0583 (trim)

7/8" HI-VIS REFLECTIVE SEGMENTED TRIM

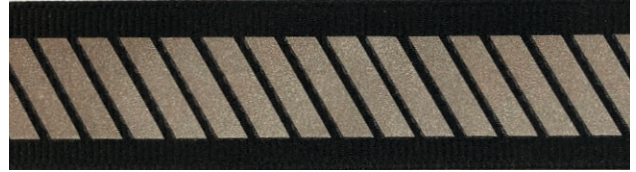

Black/Silver 7/8" EH0580



Red/Silver 7/8" EH0581



Royal Blue/Silver 7/8" EH0582



Charcoal/Silver 7/8" EH0583

TRIM SPECS:

BASE TRIM: 100% polyester grosgrain trim, 7/8"

REFLECTIVE TOP: 3M-5530 segmented reflective trim, 9/16"

WASH: Industrial Laundry Friendly

MINIMUM ORDER QUANTITY: 1 pc.

CZ ACTIVITY CODE: 2S

LOCATION CODES: Starter group of locations available. Others available upon request.

CHEF COATS

FABRIC OVERLAYS

Beginning with a corporate color story, build your program by selecting from our assortment of fabric overlay options. One selection used strategically over several items can pull together the look you want, one employee at a time.

We've done our homework to determine which fabrics can be safely applied to others, to ensure against color bleed, crocking, or differential shrinkage. That said, trim and overlay options may change as you decorate different base garments.

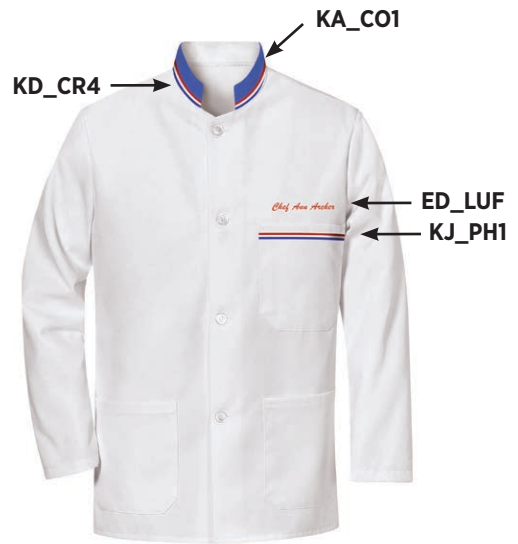

CHEF COATS CONTINUED...

Combining fabric overlays with middy braids, bias, soutache or piping can take a chef coat from prep to executive with a few clicks and a little creativity. Use the images shown here to inspire your own color stories and designs.

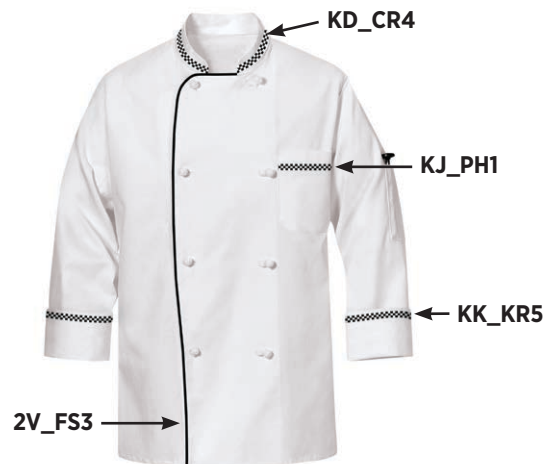

TRIMS

The following five pages provide images of our trim selection by style and color. Information included with each section will guide you as to the potential uses and wash options.

PIPING

Piping (also called cordage) is a pre-made trim and is 100% Polyester. Piping is inserted inside a seam so that the "lip" is hidden and the rounded "cord" part of the trim is exposed. Because of the prep work, or deconstruction of the garment that is necessary to add piping, it is typically more expensive than some other customization options. It can be used on a variety of garments. If pricing is sensitive consider using soutache as an alternative.

Metallic Piping - Dry Clean

Colored Piping - Home Wash or Dry Clean

("CORDED" PORTION IS 1/8" WIDE)

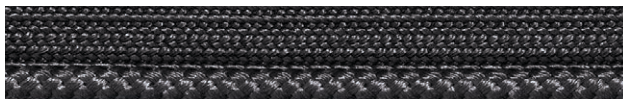

Black 1/8" **EHP062**

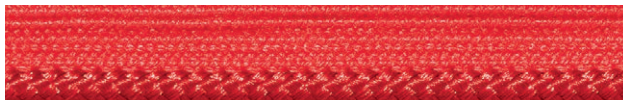

Red 1/8" **EHP066**

RIBBONS

Our ribbons are 100% Polyester and can be used in a variety of applications. Ribbon colors cannot be changed. Garments customized with ribbon can be dry cleaned, home washed, and light soil washed.



Black/White Check 1/2" **EHP051**

PATTERNED FUSED TRIM

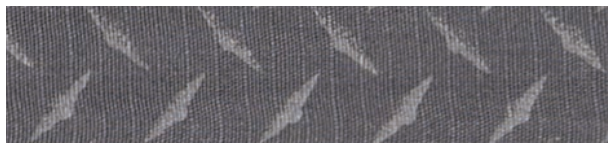

Diamond Plate 3/4" **EHP304**

MIDDY BRAID

Our 100% Polyester middy braid trim comes in two standard widths, 1/4" and 1/2" to allow for the best customization options.

Metallic Middy Braid - Home Wash or Dry Clean

Colored Middy Braid - Industrial Laundry, Home Wash or Dry Clean



Antique Gold 1/2" **EHP084**



Antique Gold 1/4" **EHP083**

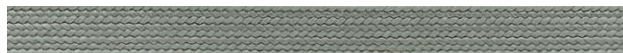

Pewter 1/4" **EHP091**



Black 1/4" **EHP023**



Burgundy 1/4" **EHP087**



Red 1/2" **EHP034**



Red 1/4" **EHP024**



Royal Blue 1/4" **EHP025**



Gold 1/2" **EHP036** Hand Wash or Dry Clean Only

SOUTACHE

Our soutache braid is 100% Polyester and can be used on many different garments. It can be used instead of piping without needing to break open a seam or can be used as an accent to work with a fabric overlay.

Metallic Soutache - Dry Clean

Colored Soutache - Home Wash or Dry Clean

Suggested Placements:

Add to the edge of an overlay or stripe on the collar and/or cuff, or to the edge of a collar/front instead of piping.



Antique Gold 1/8" **EHP086**



Black 1/8" **EHP001**



Red 1/8" **EHP005**



Navy 1/8" **EHP002**



Royal Blue 1/8" **EHP004**



White 1/8" **EHP003**

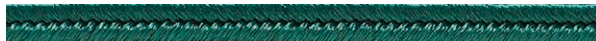

Green 1/8" **EHP079**



Gold Metallic 1/8" **EHP007**

IL FRIENDLY SOUTACHE



Red 1/8" **EW3901**



Black 1/8" **EW3902**



Royal Blue 1/8" **EW3903**

KNIT TRIM

Our knit trim is 100% Polyester and can be washed in a light soil industrial environment. Because it is a knit, it is more flexible and can maneuver around corners on collars and cuffs. Garments customized with knit trim can be industrial laundered, home washed or dry cleaned.

Suggested Placements:

Cuffs, collars and/or fronts of culinary items or aprons, or other industrial launderable service apparel items, such as lab coats or counter coats.

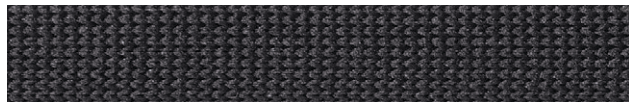

Black 1/2" **EHP040**

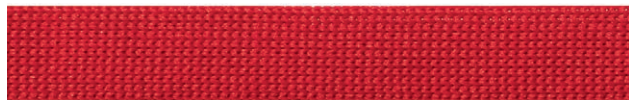

Red 1/2" **EHP041**



Kelly Green 1/2" **EHP043**

1" STRIPES



The stripes shown here are straight cut and 1" in width. They are 100% Polyester with a fused backing in order to maintain their shape and eliminate shrinkage.

These stripes can also be used for embroidering a name. This application is home wash and industrial laundry friendly and provides an alternative to name embroidery on an emblem.

Suggested Placements:

Any pant or short side seam. As a name strip for embroidery purposes, placement is usually left or right upper front.

1" PANT STRIPE COLORS



Heather Grey 1" **ES01WH**

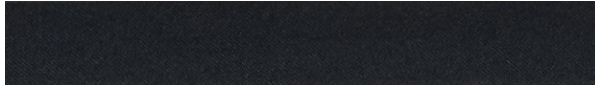

Black 1" **ES01BK**



Dark Navy 1" **ES01DN**

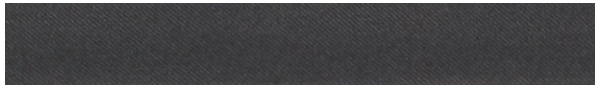

Charcoal 1" **ES01CG**

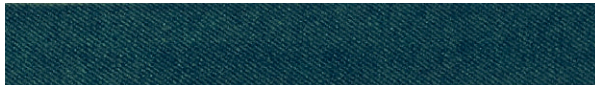

Spruce Green 1" **ES01SG**



Red 1" **ES01RD**

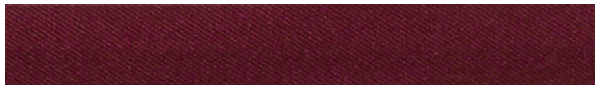

Burgundy 1" **ES01MR**

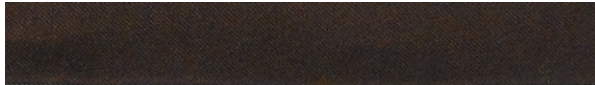

Brown 1" **ES01BR**



Khaki 1" **ES01ST**



Royal Blue 1" **ES01RB**



COVERED PLACKET COLORS - IL FRIENDLY WORK SHIRT FABRICS



Work Shirt - Navy
E83702



Work Shirt - Red
E83728

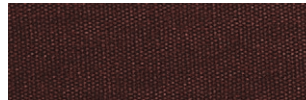

Work Shirt - Chocolate
E83725

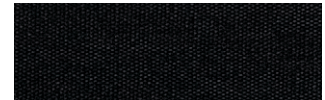

Work Shirt - Black
E83703



1" 2 COLOR STRIPES - IL FRIENDLY WORK SHIRT FABRICS



1" - Black / White
EJ5911



1" - Orange / White
EJ5912



1" - Red / White
EJ5918



1" - Royal Blue / White
EJ5919



1" - Grey / Charcoal
EJ5922

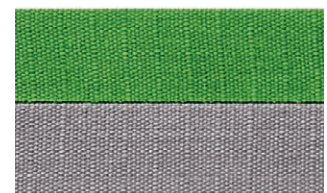

1" - Grey / Green
EJ5921



1" - Red / Silver
EJ5088

6.0 OZ. PLAIN WEAVE POPLIN

The four fabrics below are excellent options for overlays that will be industrial laundered. The additional polyester will provide better color retention.

Suggested Placements:

For use on chef coats, butcher coats and lab coats being washed in an industrial laundry application.



6.0 oz Poplin - Red **E82217**

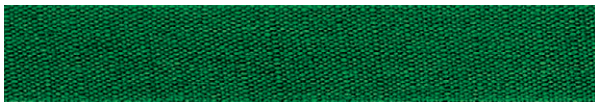

6.0 oz Poplin - Kelly Green **E82214**

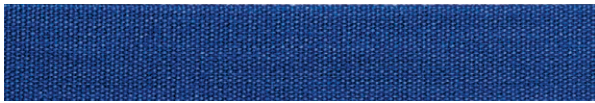

6.0 oz Poplin - Royal Blue **E82216**



6.0 oz Poplin - Black **E82219**

FABRIC OVERLAYS & BIAS TRIMS

Color swatches below represent many of the fabrics used for customization overlays and bias trims. Overlays and bias trims should match the fabric content of the garment being customized when possible. Washing instructions will not change when a garment is customized with the same fabrics or trims in different colors.

Suggested Placements:

Numerous stand-alone options including collars and cuffs in various locations, as well as on fly front plackets, shoulders and pockets. Bias trims can also complement collar and cuff overlays.

65P/35C WORK SHIRT FABRICS/ BIAS TRIM



WS Poplin - Navy

Bias J86064 | Fabric E86064



WS Poplin - Red

Bias J86073 | Fabric E86073



WS Poplin - Black

Bias J86066 | Fabric E86066



WS Poplin - Tan

Bias J83723 | Fabric E86089

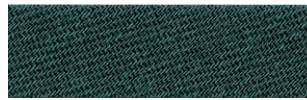

WS Poplin - Spruce Green

Bias J86075 | Fabric E86075



WS Poplin - Light Grey

Bias J86062



WS Poplin - Choc. Brown

Bias J86067 | Fabric E86067



WS Poplin - Yellow

Bias J83726



WS Poplin - Burgundy

Bias J83714 | Fabric E83714

3/4" FABRIC/BIAS TRIM



4.25 oz. Ripstop - Fused Gold

Bias EJ6001



Decorate it. Modify it. Customize it.

Contact a VF Workwear
Customer Service Representative at:
1.800.733.5271

For an online catalog, visit:
www.vfimagewear.com, and click on
the "Imagine It" link toward the
bottom of the page.